

A-1230

INSTRUCTION MANUAL

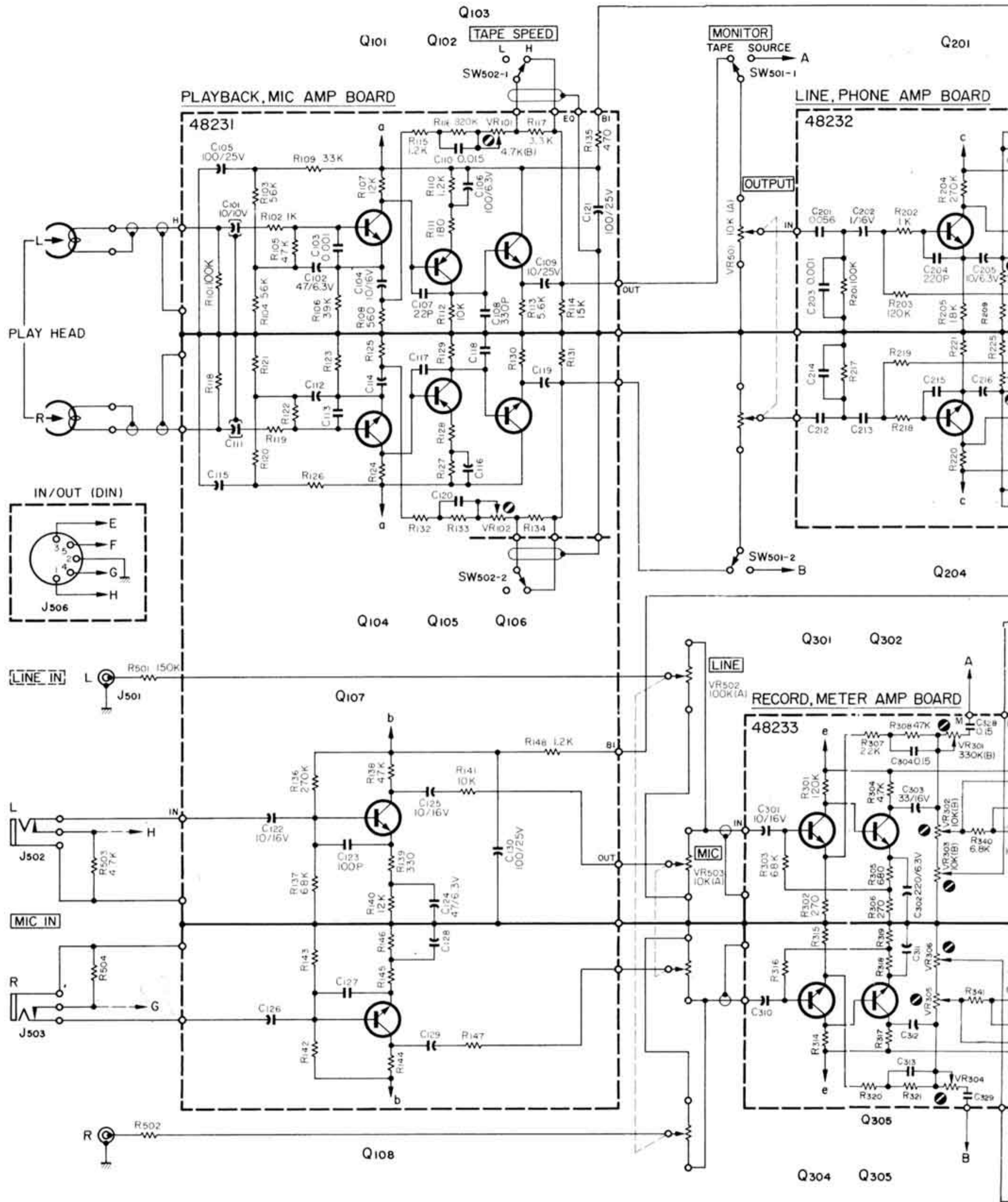

TEAC **A-1230**
STEREO TAPE DECK



CIRCUIT REF. NO.	DESCRIPTION	CIRCUIT REF. NO.	DES
Q101/104	2SC732(BL) or 2SC693(F) or 2SC1000(BL)	Q102/105	2SA 2SA 2SA
Q103/106	2SC536(E) or 2SC733(Y) or 2SC828(S)	Q107/108	2SC 2SC 2SC
		Q401/402	2SC

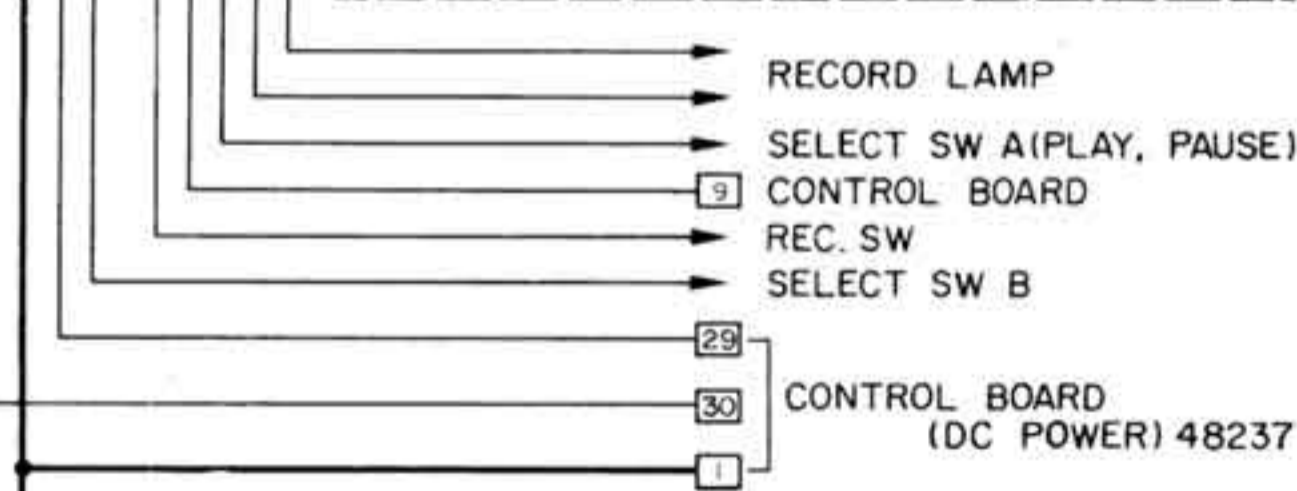
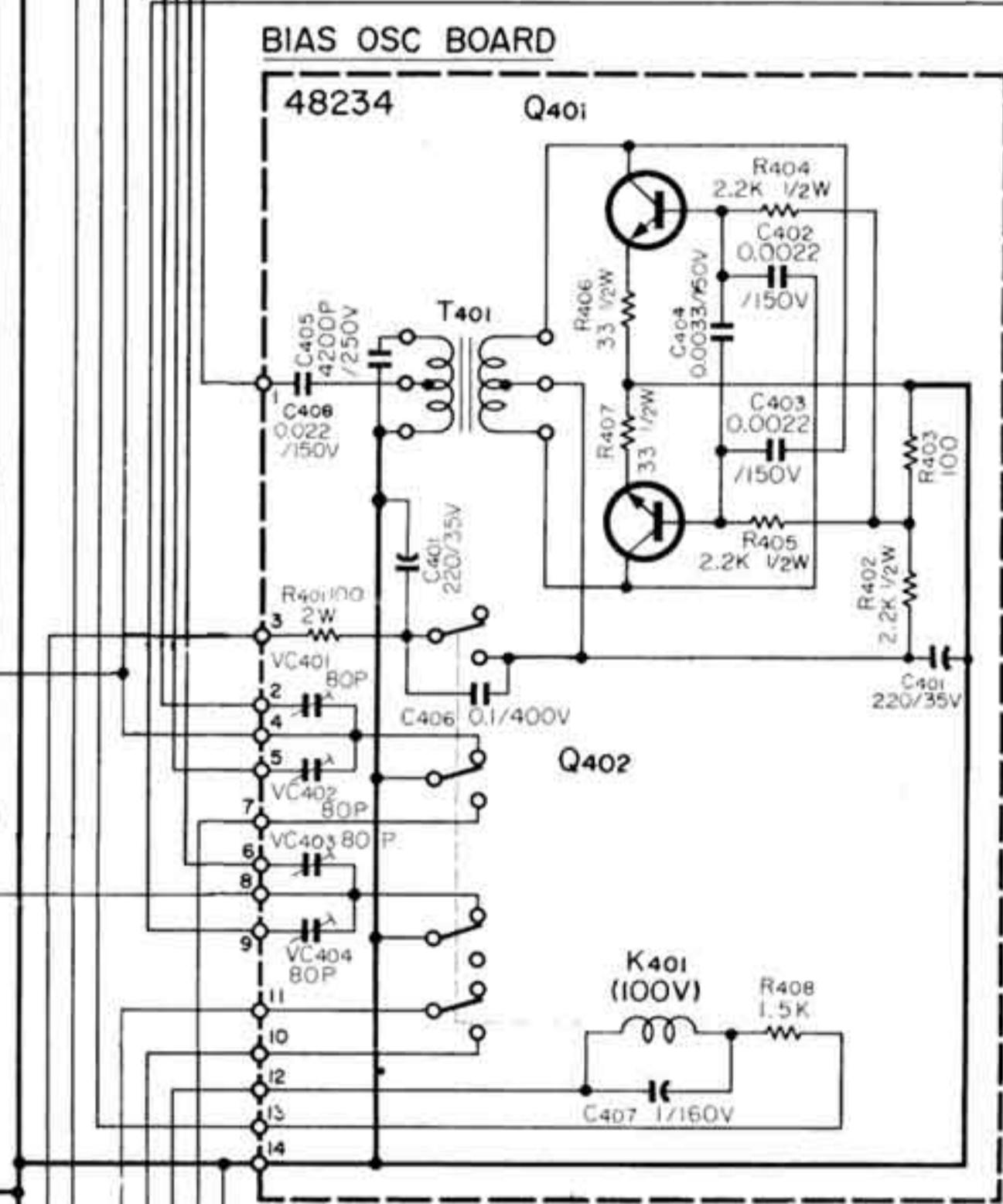
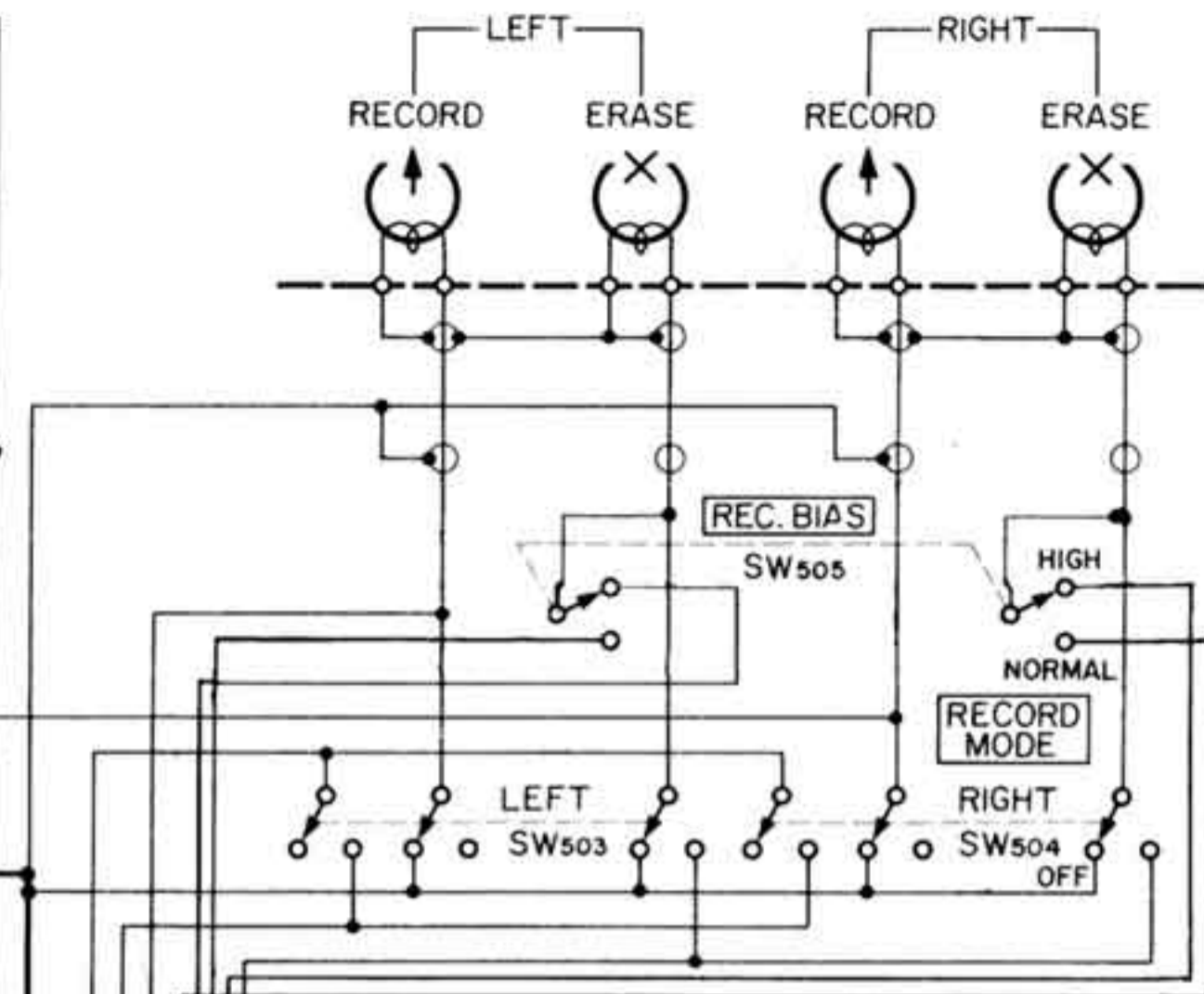
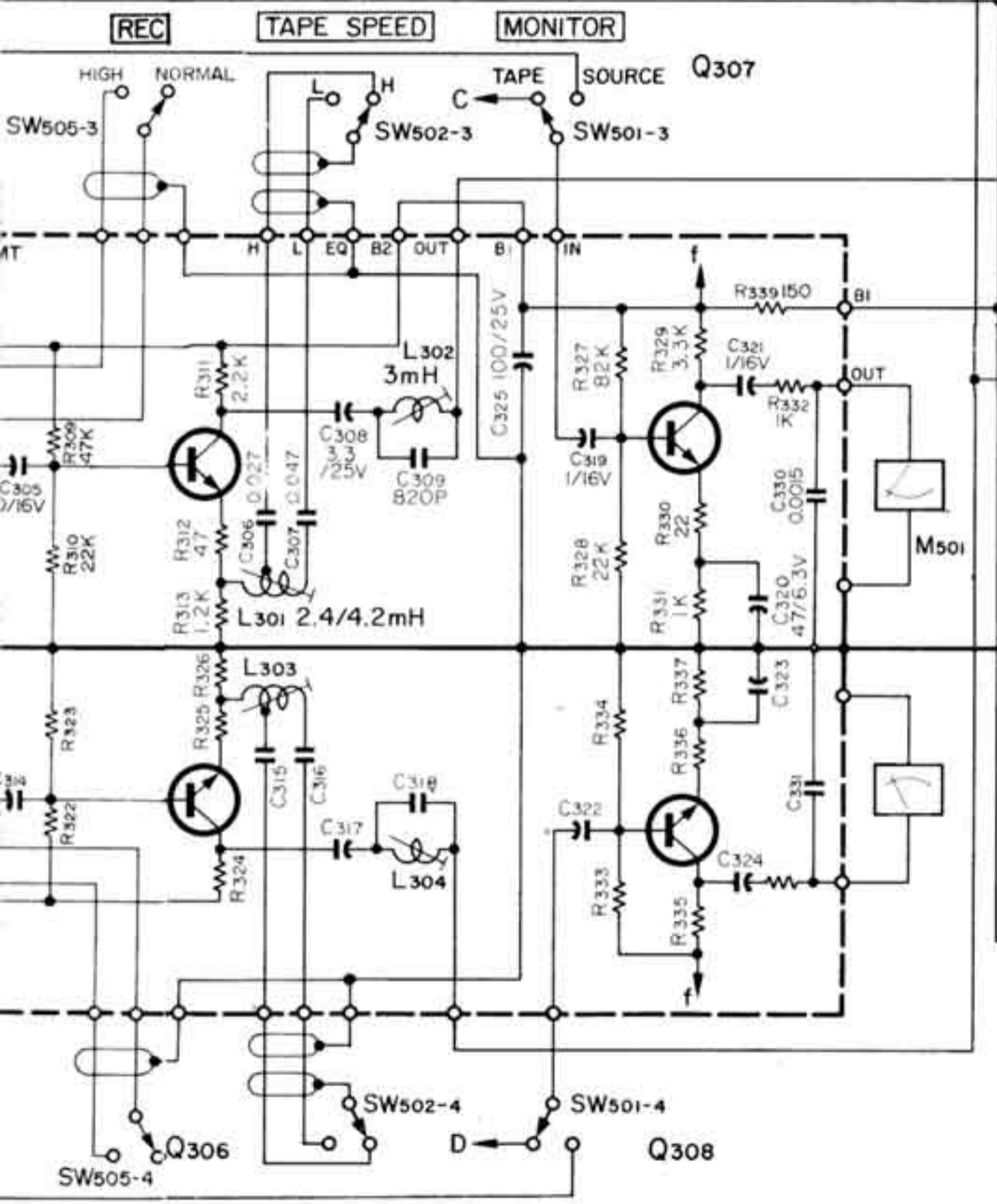
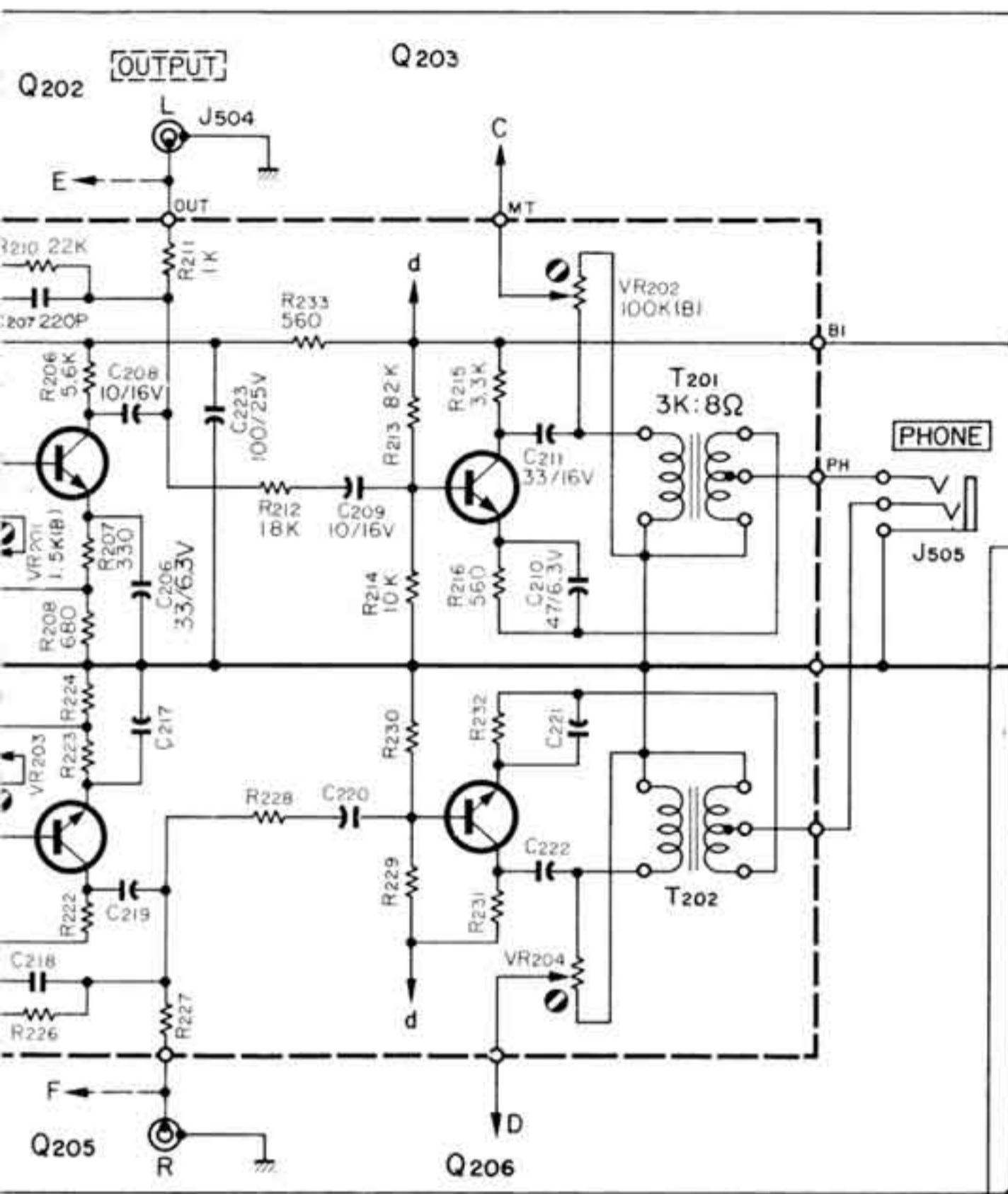

NOTES
 Schematic diagram shown in PLAYBACK mode.
 Unless otherwise specified:
 All resistors values in ohms, 1/4 watt,
 k = 1,000 ohms.
 All capacitors values in micro farads
 Ⓢ Screwdriver adjustment
 □ : on front panel, [] : on rear panel.

DESCRIPTION	CIRCUIT REF. NO.	DESCRIPTION
494 (Y) or 572 or 666 (S)	Q201/204 Q301/304 Q107/108	2SC644 (T) or 2SC369 (BL) or 2SC693 (F)
693 (F) or 828 (S) or 969 (BL)	Q203/205 Q204/206 Q307/308 Q302/305	2SC372 (Y) or 2SC536 (E) or 2SC828 (S)
971 (Y)		

6	.	
5	.	
4	.	
3	.	
2	.	
1	9-72	
REVISION	DATE	CHANGE NO.

**STEREO TAPE DECK
PREAMPLIFIER**

MODEL NO. **A-1230** SHEET NO. _____

TEAC CORPORATION

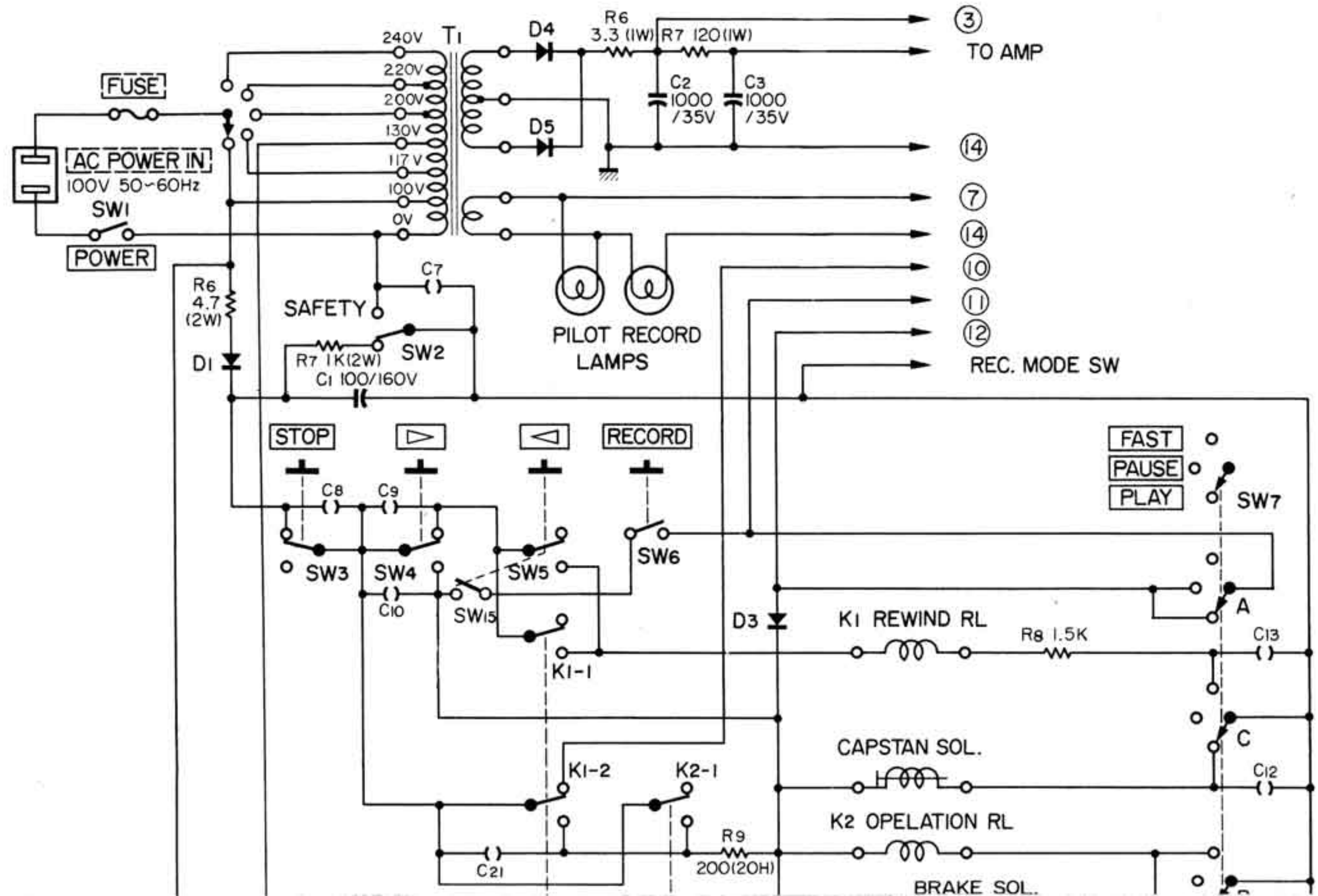
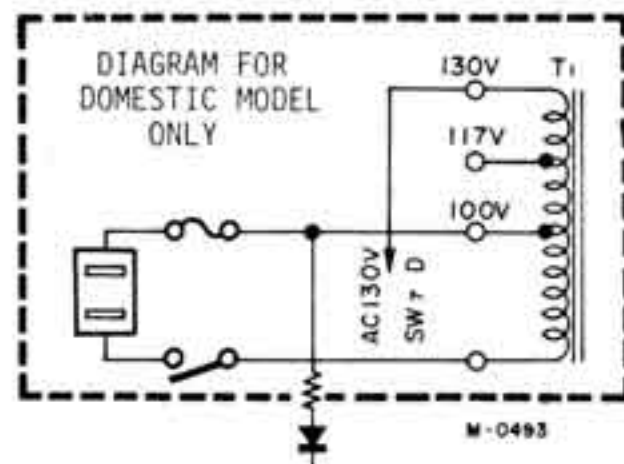
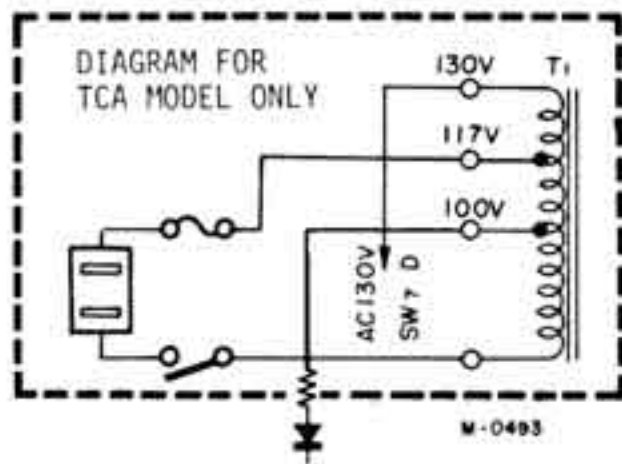

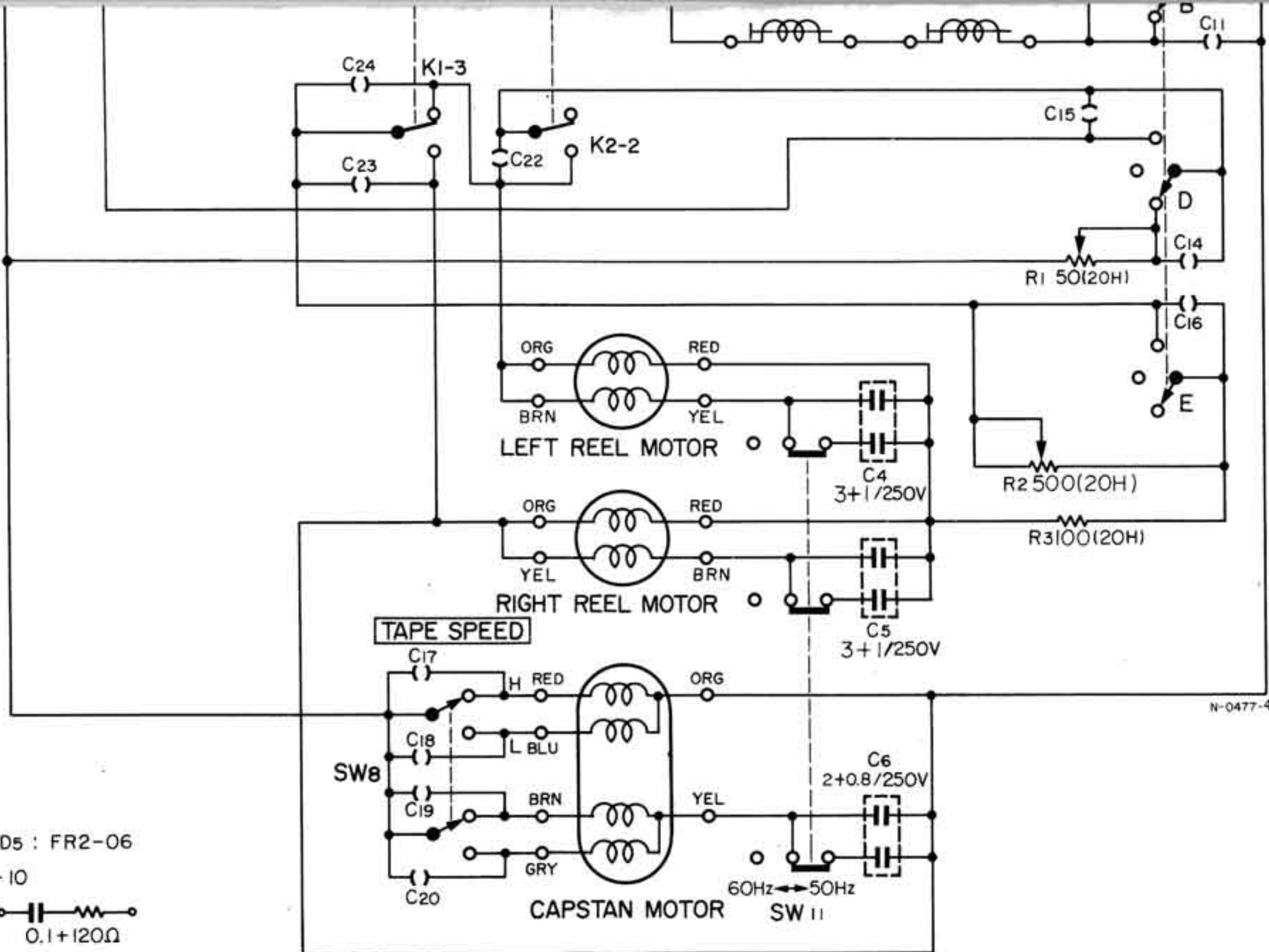

NOTES

D1, D2, D4, D5 : FR2-06

D3 : FR2-10

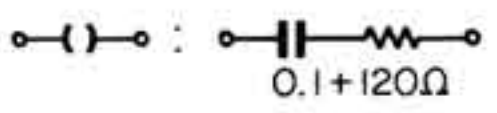

NOTES

ALL RELAYS SHOWN NOT ENERGIZED (STOP MODE)
 TAPE SPEED SWITCH SHOWN IN THE 7-1/2IPS POSITION
 FREQUENCY CONVERSION SWITCH SHOWN IN THE 50Hz POSITION

6			STEREO TAPE DECK TAPE TRANSPORT MODEL NO. A-1230 SHEET NO. TEAC CORPORATION
5			
4			
3			
2			
1	9-72		
REVISION	DATE	CHANGE NO.	